

HSA-440/2+0 M

- Surge arresters type T2+T3 ensure the equipotential bonding and reduce switching, induced and residual overvoltage in LV power supply systems.
- The products consist of varistors with big discharge ability.
- Configurations 1+1 and 3+1 are additionally combined with a gas discharge tube which ensures zero leakage current through the PE conductor.
- Installed at the boundaries of LPZ 1 – LPZ 3 into subsidiary switchboards and control panels.
- If the product contains two PE (or PEN) terminals, it must not be used as a PE (PEN) bridge.
- **M** indication specifies a type of construction with removable module.
- **S** indication specifies a version with remote monitoring.

Type		HSA-440/2+0 M
Test class according to EN 61643-11:2012 (IEC 61643-11:2011)		T2, T3
System		TN-S
Number of poles		2
Rated operating AC voltage	U_N	400 V
Maximum continuous operating voltage AC	U_C	440 V
Maximum discharge current (8/20)	I_{max}	40 kA
Nominal discharge current for class II test (8/20)	I_n	15 kA
Open circuit voltage of the combination wave generator	U_{OC}	6 kV
Total discharge current (8/20) L+N->PE	I_{Total}	80 kA
Voltage protection level at I_n	U_p	< 1.8 kV
Voltage protection level at U_{OC}	U_p	< 1.4 kV
Temporary overvoltage test (TOV) for $t_T = 5$ s	U_T	580 V
Temporary overvoltage test (TOV) for $t_T = 120$ min	U_T	762 V
Response time	t_A	< 25 ns
Maximal back-up fuse		160 A gL/gG
Residual current	I_{PE}	≤ 400 μA
Short-circuit current rating at maximum back-up fuse	I_{SCCR}	60 kA _{rms}
Lightning protection zone		LPZ 1-2, LPZ 2-3
Housing material		Polyamid PA6, UL94 V-0
Degree of protection		IP20
Operating temperature	ϑ	-40 ÷ 70 °C
Humidity range	RH	5 ÷ 95 %
Minimum cross-section of connected Cu conductors accord. to HD 60364-5-53:2022 (doesn't apply to „V“ connection) for T2	S	2.5 mm ² (L, N) 6 mm ² (PE, PEN)
Clamp fastening range (solid conductor)		1.5 ÷ 25 mm ²
Clamp fastening range (stranded conductor)		1.5 ÷ 16 mm ²
Tightening moment		3 Nm
Installation		On DIN rail 35 mm
Modular width		2 TE

Type		HSA-440/2+0 M
Operating position		Any
Product placement environment		Internal
Signalling at the device		Optic
Importance of local signalling		OK – clear target FAULT – red target
Remote signalling		No
Modular design		Yes
Article number of spare module		27 194
Lifetime		> 100 000 h
Designed according to standards		
Requirements and test methods for SPDs connected to low-voltage power systems		IEC 61643-11:2011
Safety of Flammability of Plastic Materials		UL 94
Application standards		
Protection against lightning		IEC 62305:2010
Selection and erection of electrical equipment – Switchgear and controlgear		HD 60364-5-53:2022
Selection and application principles for SPDs connected to low-voltage power systems		CLC/TS 61643-12:2009
Ordering, packaging and additional data		
Mass	m	222 g
Mass (including the packaging)	m	236 g
Packaging dimensions (H x W x D)		45 x 102 x 74 mm
Packaging value	V	0.34 dm ³
ETIM group		EG000021
ETIM class		EC000941
Customs tariff no.		85363010
EAN code		8590681116661
Art. number		27 541



The link in the QR code leads to the online presentation of the **HSA-440/2+0 M**. There, in addition to the always up-to-date data sheet, you will also find all diagrams and drawings, declarations of conformity, or 2D or 3D models and other necessary materials. For more information, visit www.hakel.com



Application wiring diagram (installation)

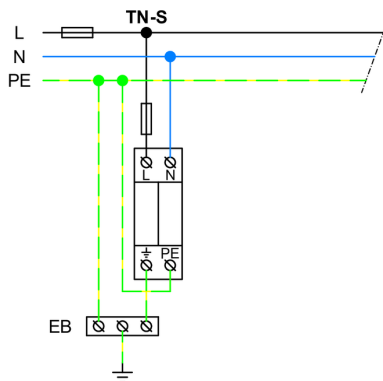

Internal diagram

